











SummitView™ Jeep Wrangler (JK/JL) Adjustable Rear Vision System

with CMOS Camera For Aftermarket Display

SUTV-8848



Recommended Tools				Difficulty Level
 Wrench	 Wire Strippers	 Wire Cutters	 Electrical Tape	
 Screw Driver	 Panel Removal Tool	 Zip Ties	 Socket Set	Install Time
Questions? Call the Brandmotion technical support line at (734) 619-1250 or CLICK HERE				 1hr 30m - 2hr

Kit Contents

Kit A

Components for installing the **SUTV-8848**



Kit Contents:

1x CMOS Camera

1x Adjustable 5th Wheel Camera Mount

1x Video Chassis Harness

1x RCA to Factory 22 Pin connector

3x Push Nuts

15x Zipties

Install Rear View Camera Chassis Harness

Part 1

Preparing the Radio

1. First, you need to gain access to the back of your aftermarket radio. If you already have access, skip to part 2.
2. Start by removing the rubber bin insert from the top of the dash
3. **Remove the 7mm bolt** under the rubber bin insert.
4. Using a plastic trim removal tool, remove the window switch panel.
5. Disconnect harness from window switches.
6. **Remove the 7mm bolt behind the window switch panel.**
7. Remove driver knee bolster cover
8. Remove (2) 7mm bolts on both sides of the steering column.
9. Remove center stack/cluster trim
10. Remove the glove box for access. You will need access to the area behind the glove box to make your connection to the radio.
11. Remove (4) 7mm bolts to remove radio from dash



Part 2

Camera functionality test (Highly recommended, not required)

1. 8837:

- a. There will be three wires accompanying the RCA: Red, Green, and Black

1. Twist red and green together = Power
2. Black = Ground

- b. Using an wire extension (not supplied)

1. Connect twisted red and green directly to positive terminal of battery
2. Connect Black to negative terminal of battery

- c. Test Camera

1. Connect RCA to Aftermarket radio and
2. Turn Key to on position
3. Place the vehicle in reverse and verify a good image.

2. 8847:

- a. There will be two wires at the rear of the harness near the camera

1. Red= Power
2. Black = Ground

- b. Using an wire extension (not supplied)

1. Connect red wire directly to positive terminal of battery
2. Connect Black to negative terminal of battery

- c. Test Camera

1. Connect RCA to Aftermarket radio and
2. Turn Key to on position
3. Place the vehicle in reverse and verify a good image.

3. 8857:

- a. There will be two wires accompanying the RCA: Red and Black

1. Red= Power
2. Black = Ground

- b. Using an wire extension (not supplied)

1. Connect Red wire directly to positive terminal of battery
2. Connect Black to negative terminal of battery

- c. Test Camera

1. Connect RCA to Aftermarket radio
2. Turn Key to on position
3. Place the vehicle in reverse and verify a good image.

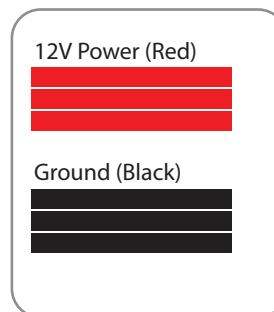
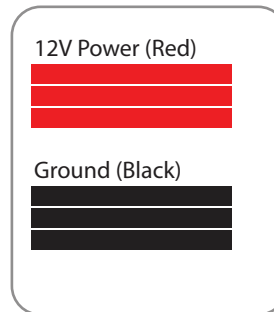
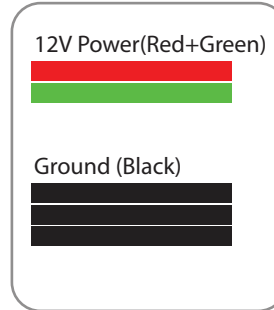

Part 3

Installing Rear Camera on Tire Carrier

1. Remove your spare tire and place the camera bracket on the top two studs.
2. Secure bracket to carrier using (2) push nuts to secure the bracket on two top studs.
3. The nylon washer will go on the bottom stud and will be secured with the third push nut.
4. Place your tire on the carrier and make any needed adjustments to the camera placement to see through the wheel spokes.
5. Once the orientation is satisfactory, tighten two adjustment screws on bracket.
6. Reinstall the spare tire on the carrier.



1



3



5



6

Install Rear View Camera Chassis Harness

1. Using a plastic trim removal tool, remove interior panels on the inside of the rear gate
2. Insert camera connector through the rear relief/vent flap behind the spare tire mount. **DO NOT RUN THROUGH CENTER HOLE OF TIRE CARRIER**
3. Gently pull harness through relief door and connect your camera harness to your chassis harness.
4. Use supplied wire ties to secure chassis harness to existing harness in the tailgate.

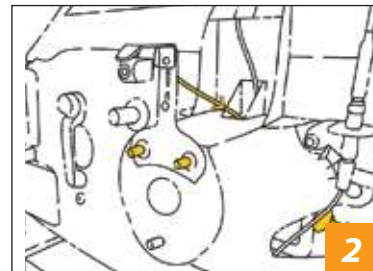

2

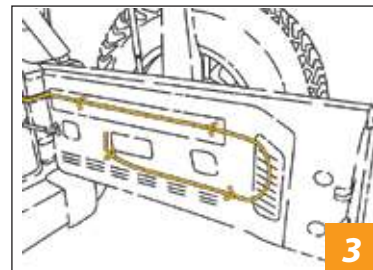

3

5. Use supplied wire ties to secure chassis harness to exterior of fabric factory wire cover connecting tailgate to body. Do not run through fabric factory wire cover. **CAUTION: Leave enough slack to allow the gate to open fully**
6. Using a plastic trim removal tool, remove rear access (behind seat belt) panel to expose 10mm bolt, and remove bolt. Failure to remove this bolt will break the panel.
7. Remove interior rear quarter panel
8. FOR 8848, you will need to ground black wire at a good chassis ground. Isolate the red wire with electrical tape. You will connect to power at the front of the vehicle in later steps.
9. Pull back carpet and continue running chassis harness forward under sill plates and B-pillar cover to passenger kick panel
10. Use a plastic trim removal tool to remove the (2) plastic push pins and remove passenger sill plate/kick panel.
11. Run the chassis harness behind the glove box and into the radio cavity.

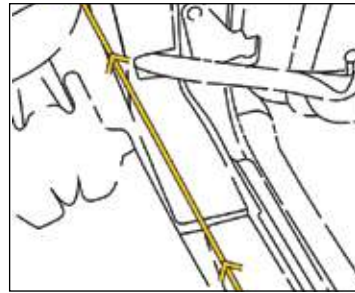
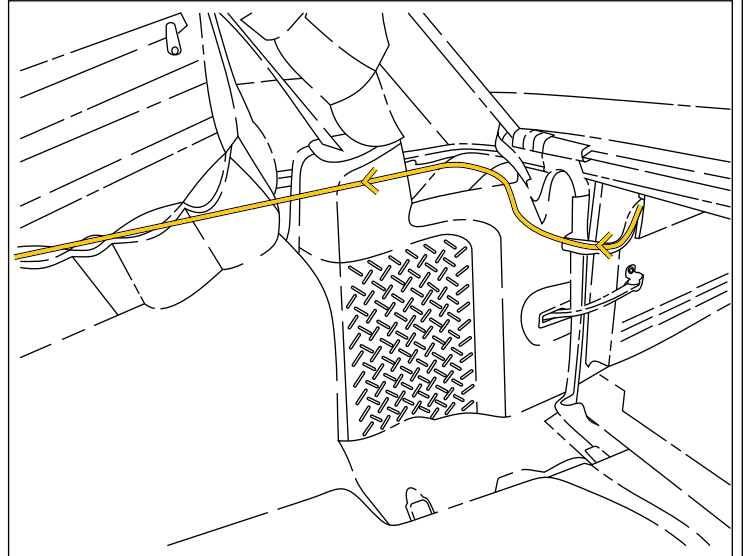

Connecting to Power

Part 1

1. 8837:
 - a. There will be three wires accompanying the RCA in the passenger kick panel: Red, Green, and Black
 1. Twist red and green together = Power
 2. Black = Ground
 - b. Identify power output from your aftermarket radio

12V Power (Red+Green)



Ground (Black)



- c. Connect twisted red and green wire to power output from radio
- d. Connect black wire to Chassis ground. We recommend using factory chassis grounding point.

2. 8847:

- a. Identify red power wire exiting the back of the yellow RCA from your camera chassis harness
- b. Identify power output from your aftermarket radio
- c. Connect Red wire to power output from your aftermarket radio
- d. Connect black wire to Chassis ground. We recommend using factory chassis grounding point.

3. 8857:

- a. Connect jumper power harness to chassis harness (if not already connected)
- b. Separate power and ground wires at jumper harness
 - 1. Red = Power
 - 2. Black = Ground
- c. Identify power output from your aftermarket radio
- d. Connect red wire to power output from your aftermarket radio.
- e. Connect black wire to Chassis ground. We recommend using factory chassis grounding point.

12V Power (Red)



Ground (Black)



12V Power (Red)



Ground (Black)



Jeep Wrangler JK 12V Power Location
(White/Grey wire by passenger kick panel)

Part 2

Power connections in Jeep Wrangler JL / JT

- 1: Remove the climate control and media control trim panels.

CAUTION

A large amount of force is required to free the panel clips that retain both of these trim pieces.

- 2: Use the figures below to create the connections to the FullVUE™ Mirror main power harness.

Power Output

12V Accessory (Red)



Ground (Black)



Wrangler JL Harness

12V Accessory (Pink/Yellow)



Ground (Black)



(power point connector) a.

12V Constant (Yellow)



12V Constant (Red/Green)



(media control connector) b.

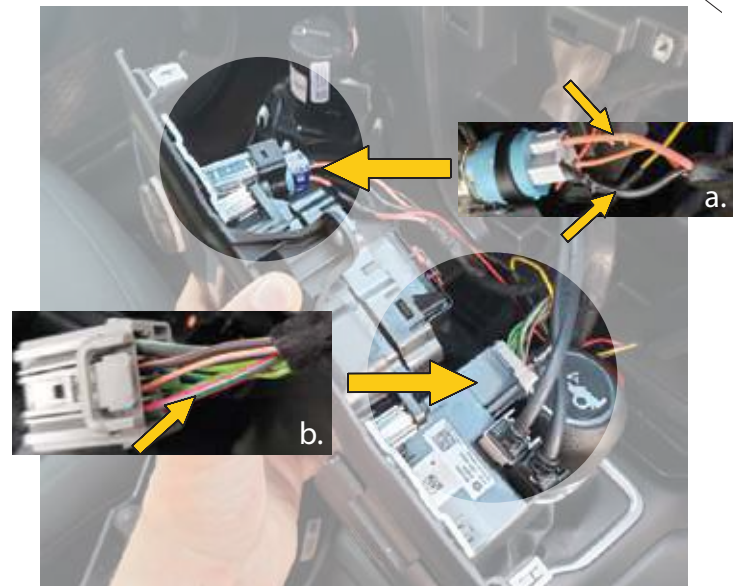
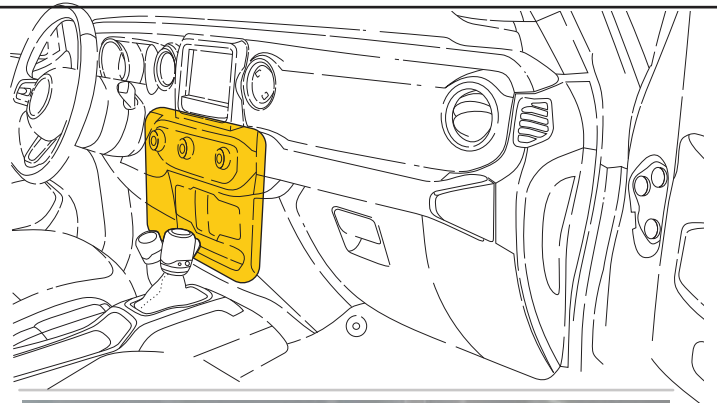

Finishing Installation

Part 1

- a. Connect male RCA of chassis harness to female RCA behind glove box.
- b. Test camera
 1. Twist red and green together = Power
 2. Black = Ground
- c. Reassemble vehicle in reverse order of removal



FAQ Section

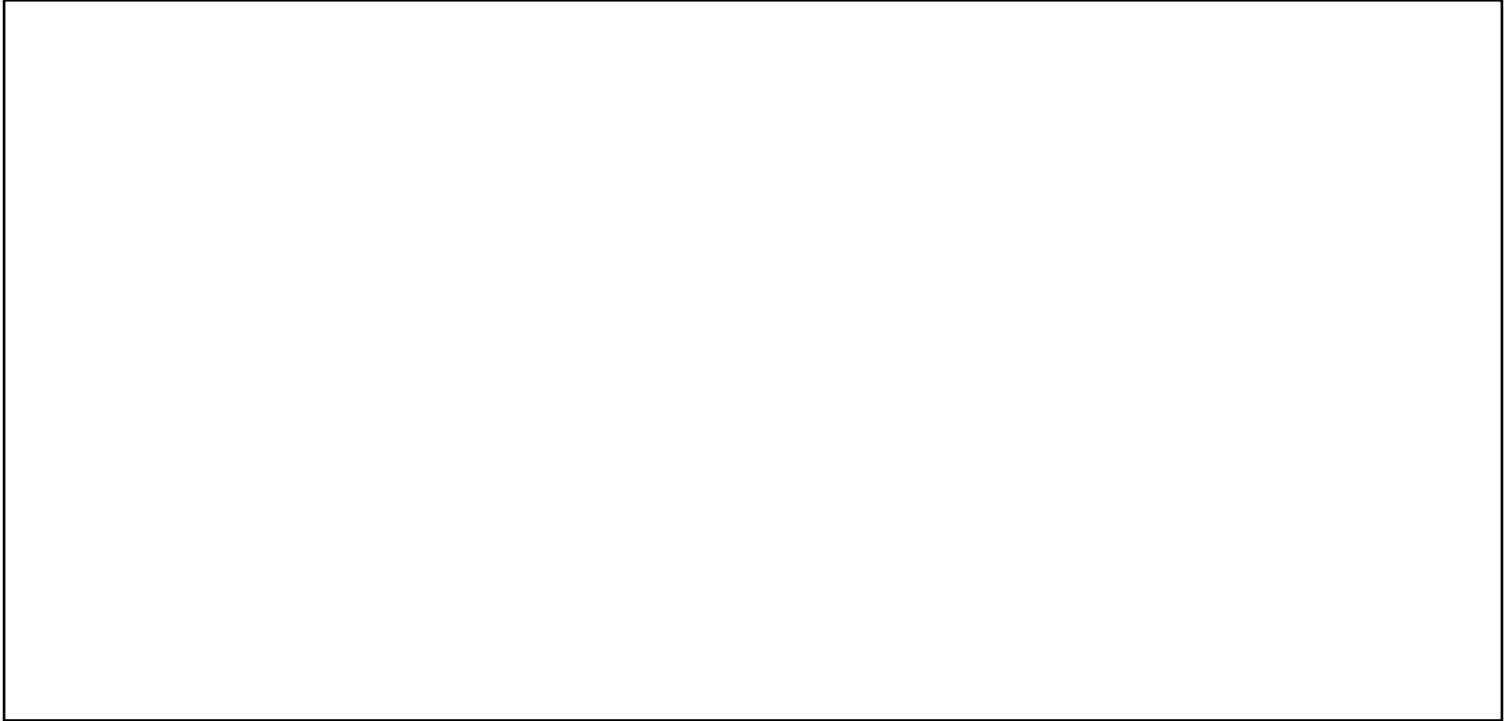

**WARNING: Cancer and Reproductive Harm -
www.P65Warnings.ca.gov**