













Wireless Transparent Trailer® System for Chevrolet & GMC 1500 (2019-Current) & Heavy Duty (2020-current)

TRNS-2191



Recommended Tools				Difficulty Level
 Wrench	 Wire Strippers	 Wire Cutters	 Electrical Tape	 Install Time  2hr 30m - 3hr
 Screw Driver	 Panel Removal Tool	 Zip Ties	 Socket Set	
Questions? Call the Brandmotion technical support line at (734) 619-1250 or CLICK HERE				

Kit Contents

Recommended Tools

Components for installing the *TRNS-2191*



Kit Contents:

1x Video Mirror & Power Harness

1x Wireless Camera & Receiver

1x 5M 4Pin Extension Cable

1x 3rd Brake Light Bracket & Camera

1x Pre-Wired Adapter Mounting Plate

1x Universal Mounting Plate



Scan this QR Code for unboxing and installation video!

Installation of the Transparent Trailer Mirror

Part 1

Attaching the Transparent Trailer Mirror to the Windshield

1. Remove the old mirror from the mount on the windshield as per manufacturer's directions. Be sure to use the proper removal tool if required.
2. Install new mirror onto the D-tab and tighten with a Phillips screwdriver.



Take care not to overtighten. Overtightening could result in a damaged windshield



Part 2

Powering the Transparent Trailer Mirror

1. Connect the power harness to the plug on the mirror. Route the harness across the top of the headliner, along the windshield, down the A-pillar, and to the desired location in the kick panel. (See page 4 for Diagram).
2. Ensure that the harness will not be pinched when trim panels are replaced.

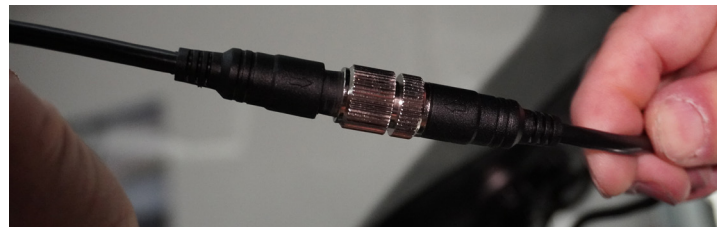

Part 2**Powering the Transparent Trailer Mirror**

1. For constant power, connect to the BCM in the driver's side dashboard. Tap into the green 25 pin plug at pin 6. Wire is purple and black.



Installation of the Transparent Trailer Mirror

Part 3

Wiring the Transparent Trailer Mirror

1. Connect the RED wire from the mirror harness to 12-volt accessory power.
2. Connect the BLACK wire to solid ground. Chassis ground in the kick panel is recommended.

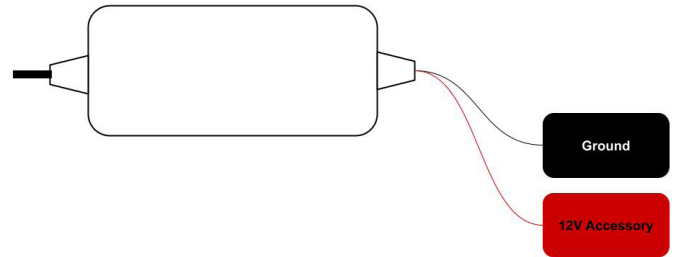

Part 4

Function test of the Transparent Trailer Mirror

1. Connect the bezel camera directly to AV1 on the mirror harness.
2. Test the mirror and camera by turning on the ignition power. You should be able to see the view from the rear camera after the mirror powers up. Note: If the mirror displays a blue screen push the button at the bottom to switch channels.



Disassembly

Part 1

Lower the rear of the Headliner

1. Remove the rear door seals off of the top of the pinch welds.
2. Use a trim removal tool to remove the cover from the coat hook.
3. Use an 8mm socket to remove the bolt from the coat hook.
4. Pull the coat hook to release the clip.
5. Use a trim removal tool to remove C-pillar plastic panels.
6. Use a 7mm socket to remove bungie from the plastic panel.
7. Slide your fingers on the inside of the back of the headliner by the rear window and feel for two plastic clips.
8. Once located gently pull from either side of the clip until it snaps out. Do this for both clips.
9. The headliner should now fall away from the rear half of the cab.(Be careful not to crease the headliner.)

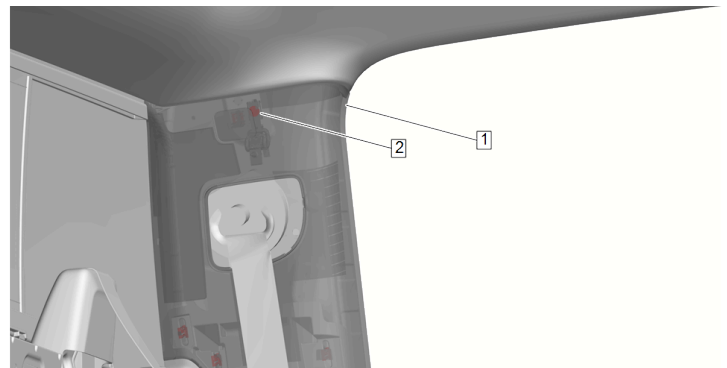
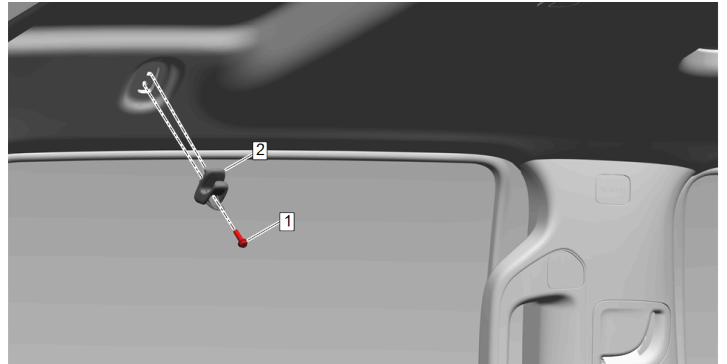

Disassembly

Part 2

Removing the Spoiler from the Rear of the Cab

1. Reach a 10mm socket behind the headliner and remove the eight nuts and four bolts that hold the spoiler on.
2. Gently pull on the spoiler from the outside until it snaps free.
3. Release power connector to free the spoiler from the cab.

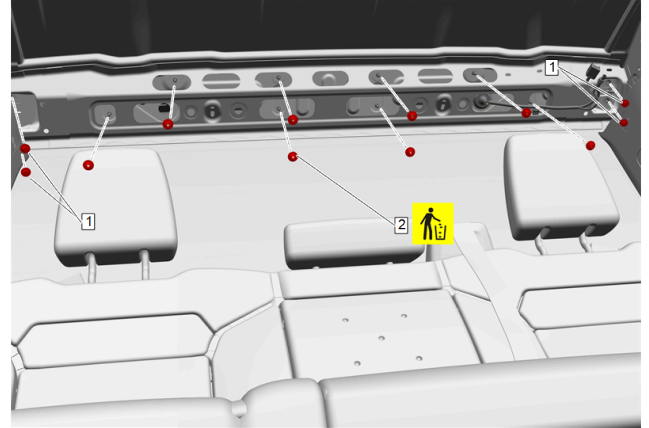

Part 3

Mounting the Camera

1. On the backside of the spoiler, remove the four Phillips screws holding the brake light into the housing.
2. Push the two retaining tabs in to release the brake light.
3. The brake light should now come out.
4. Slot the Camera Bracket over the screw posts on the third brake light.
5. Snap the brake light back in place and screw in the four Phillips screws.

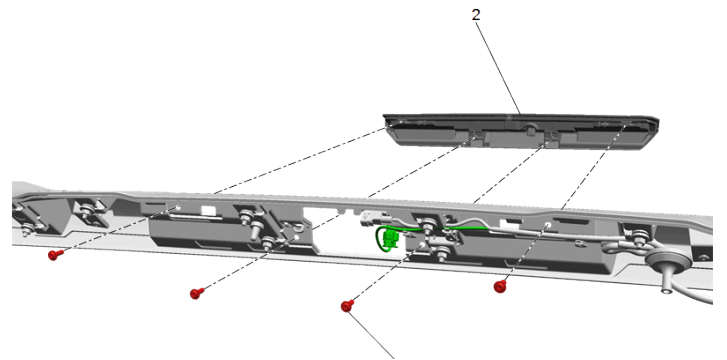

Running Wires

Part 1

Video Connector

1. Connect the additional 5m 4Pin Extension Cable to the Mirror power harness AV1
2. Run the 5m 4Pin Extension Cable through the headliner toward the brake light.
3. Pull the extension cable through the brake light opening to the outside of the cab.
4. Connect the 5m 4Pin Extension Cable to the Bezel Camera. Make sure to line up the arrows on the connectors.



Assembly

Part 1

Spoiler Reattachment

1. Reconnect the brake light plug.
2. Line up the spoiler with the holes in the cab and gently push it until it snaps in place.
3. Inside the cab, reinstall the four 10mm bolts and eight 10mm nuts.

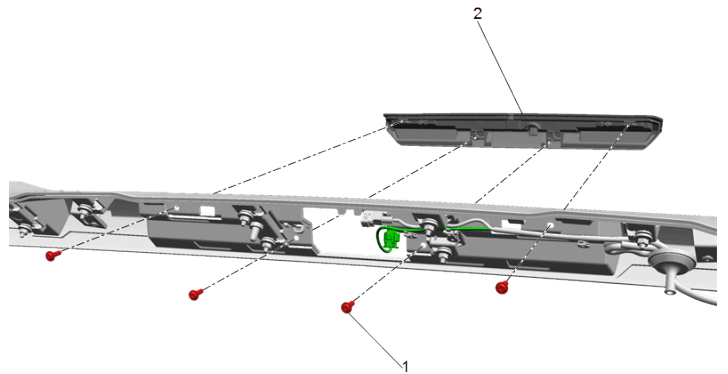

Part 2

Hanging the Headliner

1. Line up the two plastic headliner clips and snap them in place.
2. Reattach the bungie from the C-pillar panel with a 7mm socket.
3. Snap the C-pillar panel back in place.
4. Snap the coat hook back in place and screw in the 8mm bolt.
5. Snap the cover over the coat hook.
6. Put the door seals back over the pinch welds.

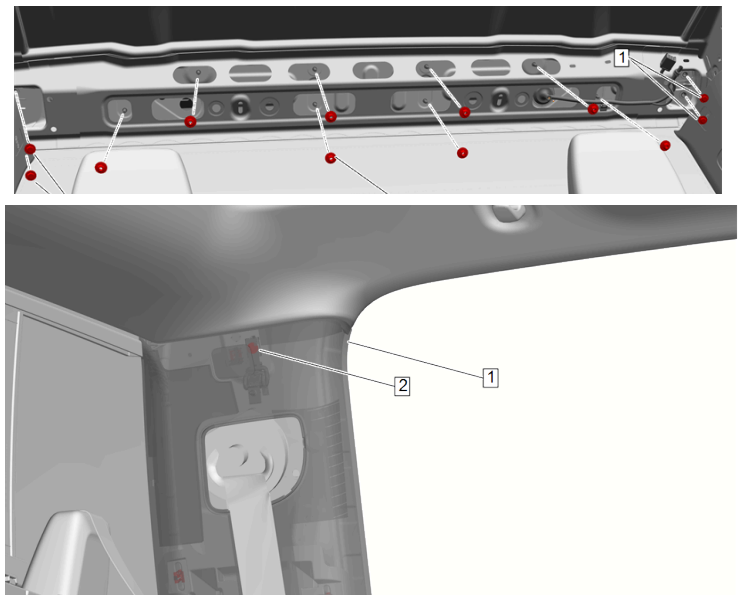

Adjustment

Part 1

Adjusting the Bezel Camera

1. If you need to change the camera's pitch, gently bend the bracket until it reaches the desired view angle.



Installation of Wireless Camera Receiver

Part 1

Connecting & Mounting the Wireless Camera Receiver

1. Connect the receiver to AV2 on the Mirror power harness
2. Find a place in the kick panel or high trim on the dash of the truck to mount the receiver.
Note: If you desire to use multiple cameras with the same receiver it is suggested to place the receiver in the glove box or somewhere easily accessible.



Camera Mounting & Power

Identify if your trailer is pre-wired for a wireless camera i.e Furion. If so, use the adapter mounting plate and power adapter (Section A). If not, use the universal mount and power harness (Section B).

Section A

Per-Wire Camera Power Connections and Mounting

1. Locate the per-wire housing mounted to the rear of the trailer.
2. Remove the 4 tiny Phillips screws holding the square cover plate on. Discard the cover plate, but Keep the screws for a later step.
3. Inside the housing, there should be a 3.5mm connector. Plug in the supplied power adaptor and tape connection.
4. Attach the adaptor mounting bracket to the back of the camera supplied in the kit to the back of the camera by using the 4 small black Phillips screws supplied in the kit.
5. Plug the power connection of the camera into the power adaptor connected in step 3. Tape the connector.
6. Push all the extra wire slack into the hole that is in the housing where the power wire is coming from.
7. Attach the antenna to the camera.
8. Aline the mounting plate to the 4 holes in the housing. Attach the mounting plate with the 4 screws removed in step 2. Be careful not to over-tighten the screws.
9. Test the camera with the monitor by turning on the parking light of the vehicle to supply power to the camera.
10. If the camera does not show on any channel follow the instructions for connecting additional cameras.

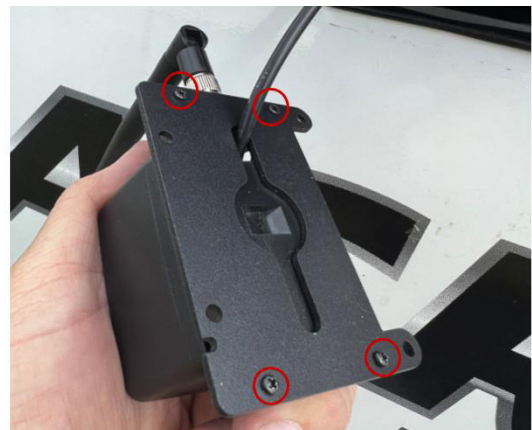

Camera Mounting & Power

Section B

Universal Camera Power Connection and Mounting

1. Remove the rear center top marker light so the wiring is exposed.
2. Splice the power harness into the power & ground wires that are connected to the light.
3. Feel inside the hole where the light power wires are coming through to find out where the "stud" of the trailer wall is to see where you can drill a hole to run the power connector of the harness through for the camera. (If the stud is next to the power wire hole, drill a ½ inch hole under the center marker light. If the stud is under the power wire hole, drill a ½ inch hole next to the center light between the center and right side marker light.
4. Run the connector or the camera power harness through the hole just drilled.
5. Reinstall the light that was removed in step 1. Make sure the base plate of the light is sealed to the trailer wall to prevent water from entering.
6. Connect the universal mounting plate to the back of the camera by using the 4 small black Phillips screws.

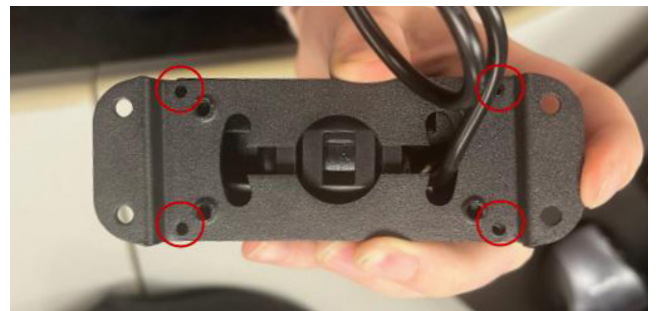
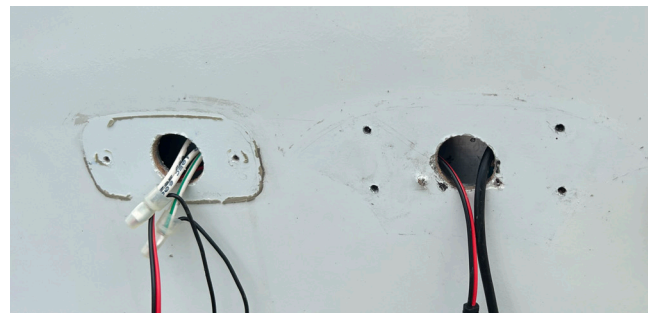

Camera Mounting & Power

Section B

Universal Camera Power Connection and Mounting Cont.

1. Connect the power harness to the camera. Tape the connector to make sure it does not come unplugged.
2. Push all the extra wire slack into the drilled hole, until the camera bracket touches the trailer. Mark the 4 holes to drill for mounting.
3. Pull the camera away from the trailer and drill the 4 ____inch holes.
4. Push the wires back in the hole and seal them with silicone. Mount the camera with 4 Phillips screws that were just drilled.
5. Attach the antenna to the camera.
6. Test the camera with the monitor by turning on the parking light of the vehicle to supply power to the camera.
7. If the camera does not show on any channel follow the instructions for connecting additional cameras.

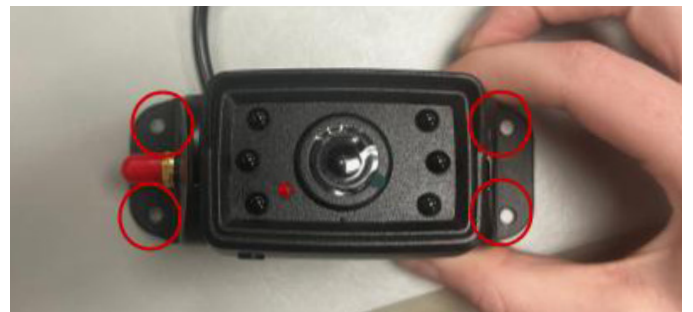

Pairing a New/Additional Camera

Part 1

Pairing a New/Additional Camera

1. Follow steps from either Section A: Per-Wire Camera Power Connections and Mounting or Section B: Universal Camera Power Connection and Mounting to connect the new camera.
2. Disconnect power to the wireless camera but keep the mirror on. You have 45 seconds from when the camera turns on to connect.
3. Power the wireless camera, press & hold the button the on receiver until the Mirror shows "pairing"